

MFJ-1886

Receive Loop Antenna

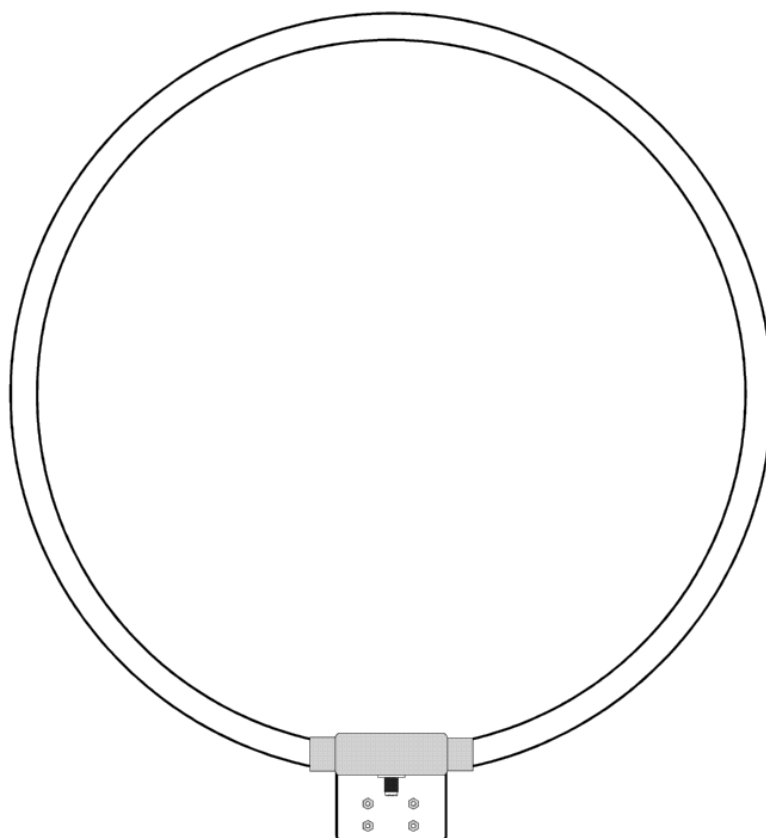

INSTRUCTION MANUAL

CAUTION: Read All Instructions
Before Operating Equipment

MFJ

300 Industrial Park Road
Starkville, MS 39759 USA
Tel: 662-323-5869 Fax: 662-323-6551

COPYRIGHT © 2015 MFJ Enterprises Inc.

GENERAL INSTALLATION INSTRUCTIONS FOR MAST MOUNTED ANTENNAS

1. Assemble your new antenna on the ground at the installation site. Keep separate assembly instructions that come with it. Large CB and Amateur beams may have to be finally assembled on the tower or mast.
2. On the ground, clamp the antenna to mast and connect the coaxial cable to the antenna.
3. To insure that the mast does not fall the "wrong way" it should get away during the installation or takedown, durable non-conductive rope should be secured at each two foot level as the mast is raised. The boss stands in a position where he can yank or pull the ropes if the need arise to deflect the falling mast away from hazards (such as power lines) into a "safe fall" (such as a yard or driveway). The ropes are tied taut at the base of the mast after installation and in place at the various levels.
4. Install selected mounting bracket.
5. If you are going to use guy wire installation instead of a mounting bracket:
 - install guy anchor bolts
 - estimate length of guy wire and cut
 - attach a mast using guy ring
6. Carefully take antenna and mast assembly to mounting bracket and insert. Tighten camp bolts. In case of guyed installation, it will be necessary to have at least a second person hold the mast upright while the guy wires are attached and tightened to the anchor bolts.
7. Install self-adhering "DANGER" label packaged in antenna hardware kit at eye level on your mast.
8. Install ground rod to drain off static electricity build-up and connect ground wire to mast and ground rod. Use special ground rods, not a spare piece of pipe.

EXAMPLE OF ANTENNA GROUNDING AS PER NATIONAL ELECTRICAL CODE INSTRUCTIONS

1. Use No.10 AWG copper or No. 8 AWG or larger copper-clad steel or bronze wire, as ground wires for both mast and lead-in. Securely clamp the wire to the bottom of the mast.
2. Secure lead-in wire from antenna to antenna discharge unit and mast ground wire to house with stand-off insulators spaced from 4 feet (1.2 meters) to 6 feet (1.8 meters) apart.
3. Mount antenna discharge unit as close as possible to where the lead-in wire enters the house.
4. Drill a hole in wall (CAREFUL! There are wires in that wall.) near your set just large enough to permit entry of cable.
5. Push cable through hole and form a rain drip loop close to where it enters the house.
6. Put small amount of caulking around cable where it enters house to keep out drafts.
7. Install static electricity discharge unit.
8. Connect antenna cable to the set.

You should not attempt to raise a mast in excess of 30 feet in height/length (not including the antenna proper) in a fully-extended condition. Thirty to fifty foot tubular masts must be elevated, a section at a time, with the base or outer section secured in place with guy wires. GET PROFESSIONAL HELP.

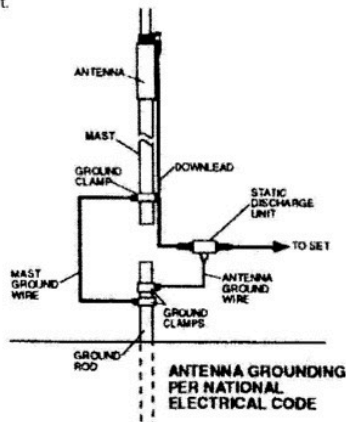

WARNING

INSTALLATION OF THIS PRODUCT NEAR POWER LINES IS DANGEROUS. FOR YOUR SAFETY, FOLLOW THE ENCLOSED INSTALLATION DIRECTIONS.

HOW TO INSTALL YOUR OUTDOOR ANTENNA SAFELY IN ACCORDANCE WITH THE RECOMMENDATIONS OF THE U.S. CONSUMER PRODUCT SAFETY COMMISSION

YOU, YOUR ANTENNA, AND SAFETY

Each year hundreds of people are killed, mutilated or receive severe permanent injuries when attempting to install an antenna. In many of these cases, the victim was aware of the danger of electrocution, but did not take adequate steps to avoid the hazard.

For your safety, and to help you achieve a good installation, please **READ** and **FOLLOW** the safety precautions below. **THEY MAY SAVE YOUR LIFE!**

1. If you are installing an antenna for the first time, please, for your own safety as well as others, seek **PROFESSIONAL ASSISTANCE**. Consult your dealer. He can explain which mounting method to use for the size and type antenna you are about to install.
2. Select your installation site with safety, as well as performance, in mind. (Detailed information on Site Selection appears in a separate section of this booklet.) **REMEMBER: ELECTRIC POWER LINES AND PHONE LINES LOOK ALIKE. FOR YOUR SAFETY, ASSUME THAT ANY OVERHEAD LINES CAN KILL YOU.**
3. Call your electric power company. Tell them your plans and ask them to come look at your proposed installation. This is a small inconvenience considering **YOUR LIFE IS AT STAKE**.
4. Plan your installation procedure carefully and completely **before** you begin. Successful raising of a mast or tower is largely a matter of coordination. Each person should be assigned to a specific task, and should know what to do and when to do it. One person should be designated as the "boss" of the operation to call out instructions and watch for signs of trouble.
5. When installing your antenna, **REMEMBER: DO NOT** use a metal ladder. **DO NOT** work on a wet or windy day. **DO** dress properly -shoes with rubber soles and heels, rubber gloves, long sleeve shirt or jacket.
6. If the assembly starts to drop, get away from it and let it fall. Remember, the antenna, mast, cable and metal guy wires are all excellent conductors of electrical current. Even the slightest touch of any of these parts to a power line complete an electrical path through the antenna and the **installer-THAT'S YOU!**
7. If any part of the antenna system should come in contact with a power line-**DON'T TOUCH IT OR TRY TO REMOVE IT YOUR SELF. CALL YOUR LOCAL POWER COMPANY.** They will remove it safely.

If an accident should occur with the power lines call for qualified emergency help immediately.

931525_AB





Introduction

Thank you for purchasing the MFJ-1886 receive loop antenna. Your new antenna is composed of high strength material for excellent rigidity and light weight. The MFJ-1886 is compact and excellent for restricted space or portable installations. The MFJ-1886 antenna frequency range extends from 30Mhz all the way down into the 500 Khz AM Broadcast bands. The antenna has strong null points and a rotator is recommended for seeking out weak stations by eliminating noise or other stations. It can be mounted on a tripod for temporary locations or any mast 1-3/4 diameter or smaller for permanent installation.

Preparation

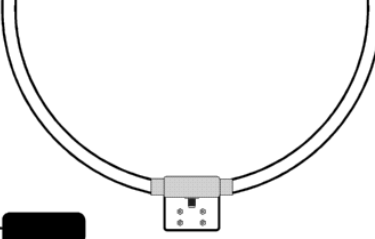
This antenna is fully assembled and ready to mount. Pick a mounting location well away from any other transmitting antennas. Transmitting signals close to the MFJ-1886 will damage the internal amplifier. This antenna can be used indoors if desired. Rotating the antenna by hand is a good way to null noise or other broadcast stations in the area. Indoor locations tend to have more noise sources than outdoor locations so keep that in mind if you decide to use the antenna inside.

In the box

1. Loop Antenna 
2. Bias Tee 
3. Power Supply 
4. U-bolts 

WARNING

KEEP THIS ANTENNA
AWAY FROM POWER LINES

Never mount or move any antenna where it can come into contact with power lines. If this antenna comes into contact with power lines, it can KILL you. Never mount any antenna where if it falls it could come into contact with power lines.

What you will need

1. Coax jumper for connecting bias tee to radio.
2. Coax cable for connecting bias tee to loop antenna
3. This antenna uses SO-239 connectors. If your receiver uses BNC or other connectors, you will need an adaptor.

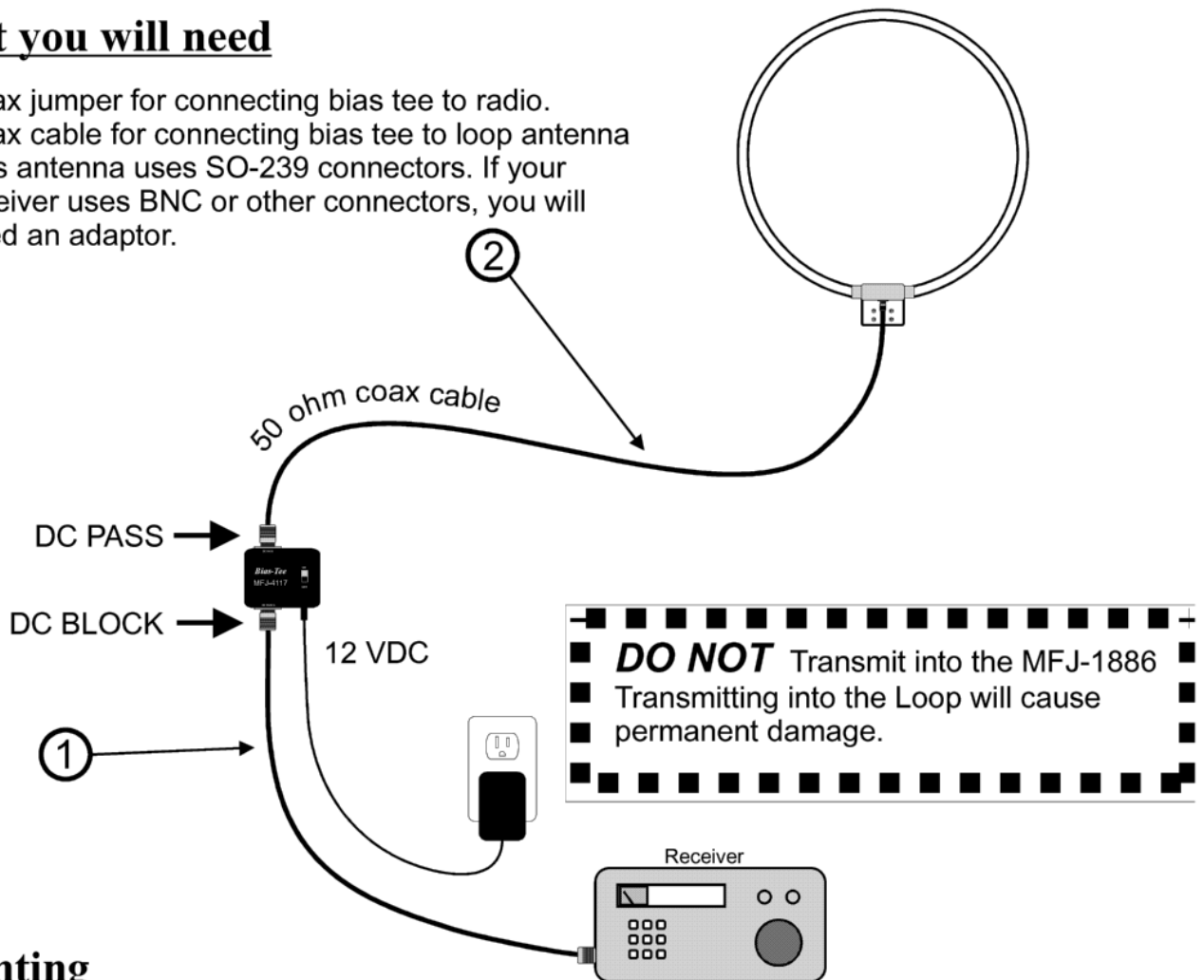

Mounting

Use the two supplied u-bolts to secure the loop to your mast as shown. Your mast should be no more than 1-3/4 in diameter and should be sturdy enough to support the MFJ-1886 antenna.

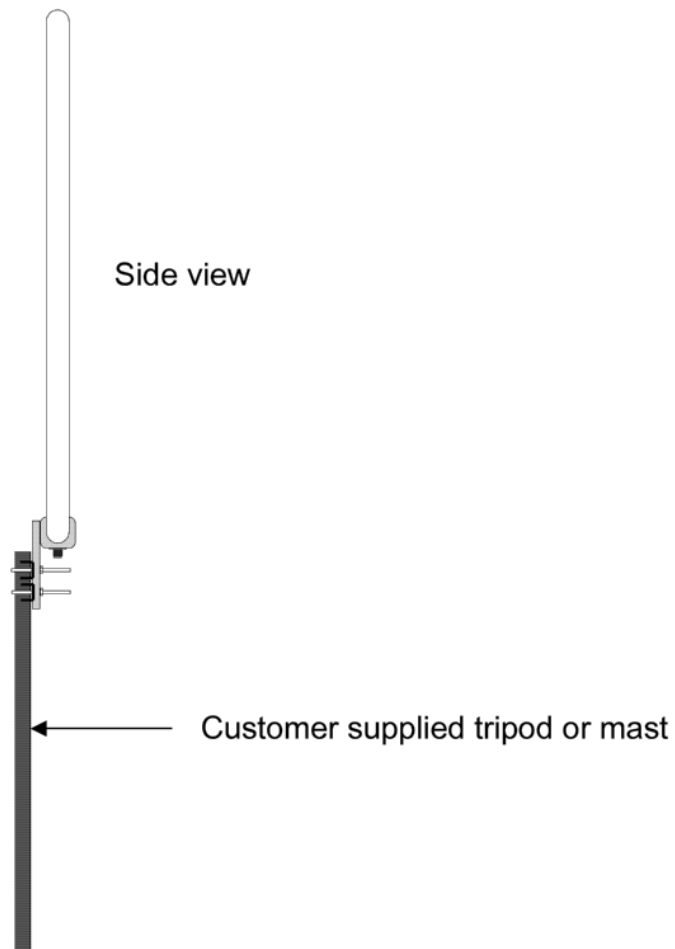

SITE SELECTION

Before attempting to install your antenna, think where you can best place your antenna for **safety** and performance.

To determine a safe distance from wires, power lines and trees:

1. Measure the height of your antenna.
2. Add this length to the length of your tower or mast, and then
3. Double this total for the minimum recommended safe distance.

If you are unable to maintain this safe distance, **STOP! GET PROFESSIONAL HELP.** Many antennas are supported by pipe masts attached to the chimney, roof or side of the house. Generally, the higher the antenna is above the ground, the better it performs. Good practice is to install your antenna about 5 to 10 feet above the roof line and away from power lines and obstructions. Remember that FCC limits your antenna height to 60 feet. If possible, find a mounting place directly above your set, where the antenna wire can take a short, vertical drop on the outside of the house for entry through a wall or window near the set. Your dealer carries a complete line of installation hardware.

AVOID THIS LOCATION

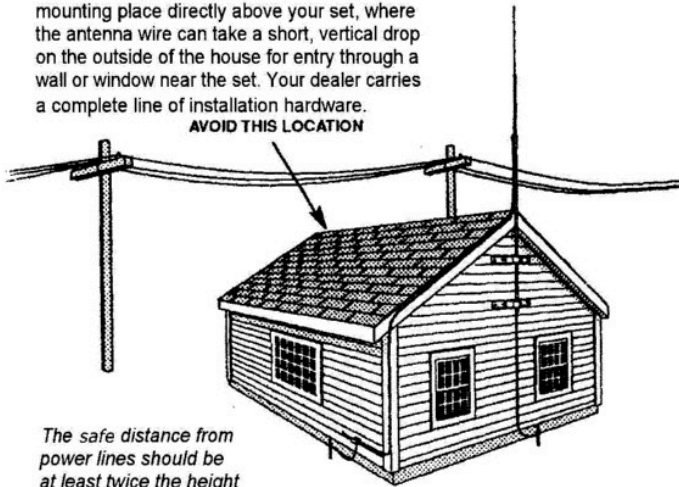

The safe distance from power lines should be at least twice the height of the antenna and mast combined.

CHOOSE A PROPER SUPPORT AND MOUNTING METHOD

However you decide to mount and support your antenna always make sure that safety is your first concern. Some of the more common installation methods are illustrated below.

ROOF MOUNTED

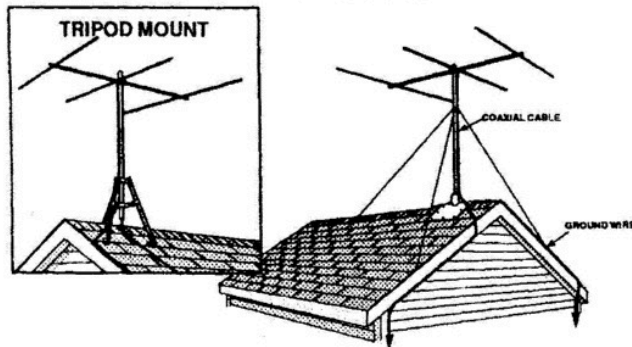

ROOF MOUNTING

The swivel feature of "universal" type mounting brackets makes a convenient antenna mount for flat or peaked roofs. One clamp type bracket is used with 3 or 4 guy wires equally spaced around the mast and anchored to the roof or eaves by eyebolts. Apply roofing compound around the base of the bracket, screws and eyebolts for moisture sealing.

TELESCOPING MAST

Guy wires should be equally spaced in at least three directions. Use at least three guy wires for each 10 foot section of mast.

SIDE OF HOUSE MOUNTING

The safe distance from power lines is at least twice the height of antenna and mast combined. Where roof overhang is not excessive, the side of the house provides a convenient mounting. Position the brackets over a stud if possible, one above the other, and space two or three feet apart. For metal siding, first mark mounting holes, then drill pilot holes through the siding to accept mounting screws.

TOWER

Tower safety is paramount to a good installation and requires that you take location, tree growth, soil depth and proximity to buildings into consideration. Tower foundations must be securely based on a solid concrete/ tower mounting plate. An alternative is to sink a 4-6 foot section of tower into a concrete base for an extremely rugged mount. Proper guying is essential to a safe weather-resistant installation that must handle severe wind loading and is best accomplished with preformed guy grips, torque brackets and turnbuckles. When working on towers always use a safety belt made of high quality web-type material

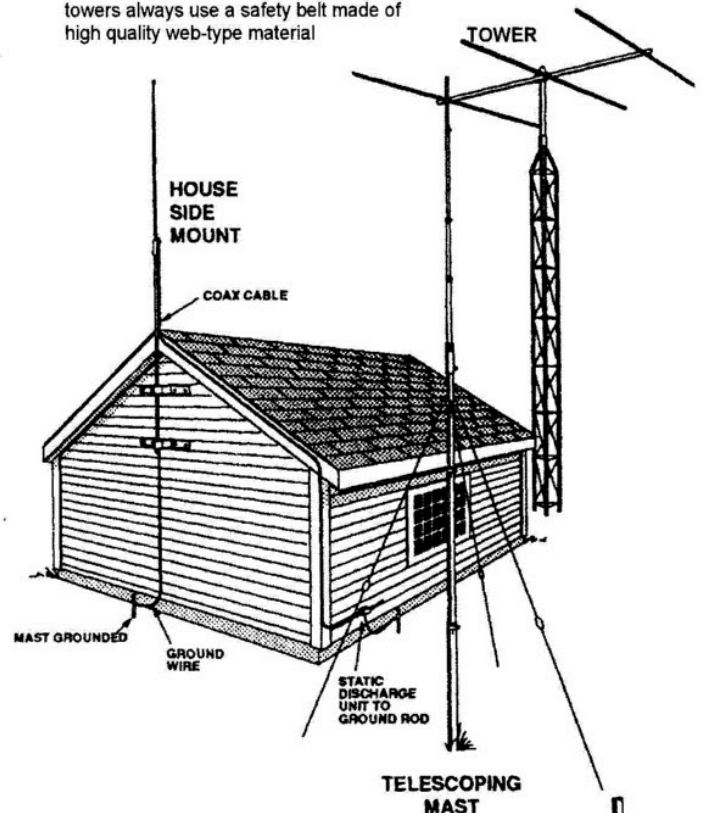

CHIMNEY MOUNTING

The chimney is often an easy and convenient mounting place. But the chimney must be strong enough to support the antenna in high winds. Do not use a chimney that has loose bricks or mortar. A good chimney mount makes use of a 5 or 10 foot, 1-1 1/4" diameter steel mast, and a heavy duty two strap clamp-type bracket. Install the upper bracket just below the top course of bricks, and the lower bracket two or three feet below the upper bracket. For maximum strength, space the brackets as far apart as possible.

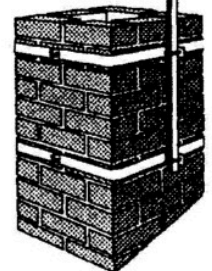

Operation

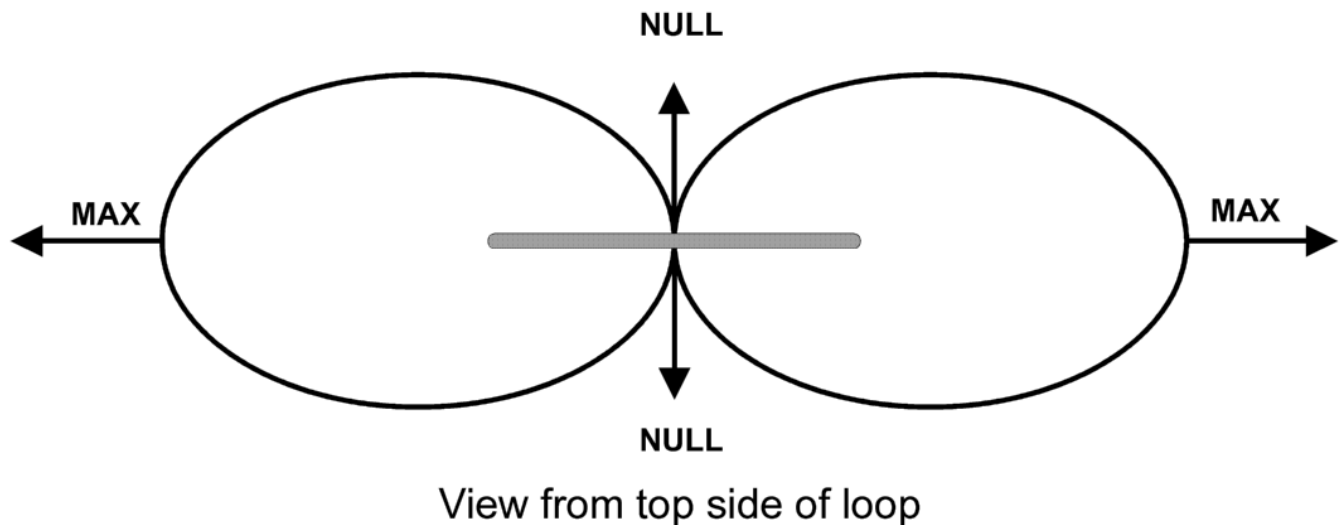

Inside or outside the operation of the antenna is basically the same. Rotation of the antenna is important so turning it by hand or with a rotator will increase the effectiveness of receiving distant stations.

Two null points on the antenna will allow directional receiving. This means noise or other interference can be reduced by placing the noise source in the direction of the null point. It is not necessary for you to know which direction the antenna is pointed, simply rotate the antenna until you hear the noise go away or it is greatly reduced.

You may not be able to null close or very strong stations because their signal may be coming from multiple directions (bouncing around). When you null a station, it allows you to hear other signals that are on or close to the same frequency as the nulled station. You may be able to hear stations that you were not able to hear before.

Notes

12 MONTH LIMITED WARRANTY

MFJ Enterprises, Inc. Warrants to the original owner of this product, if manufactured by MFJ Enterprises, Inc. and purchased from an authorized dealer or directly from MFJ Enterprises, Inc. to be free from defects in material and workmanship for a period of 12 months from date of purchase provided the following terms of this warranty are satisfied.

1. The purchaser must retain the dated proof-of-purchase (bill of sale, canceled check, credit card or money order receipt, etc.) describing the product to establish the validity of the warranty claim and submit the original or machine reproduction of such proof-of-purchase to MFJ Enterprises, Inc. at the time of warranty service. MFJ Enterprises, Inc. shall have the discretion to deny warranty without dated proof-of-purchase. Any evidence of alteration, erasure, or forgery shall be cause to void any and all warranty terms immediately.
2. MFJ Enterprises, Inc. agrees to repair or replace at MFJ's option without charge to the original owner any defective product under warranty, provided the product is returned postage prepaid to MFJ Enterprises, Inc. with a personal check, cashiers check, or money order for \$7.00 covering postage and handling.
3. MFJ Enterprises, Inc. will supply replacement parts free of charge for any MFJ product under warranty upon request. A dated proof-of-purchase and a \$5.00 personal check, cashiers check, or money order must be provided to cover postage and handling.
4. This warranty is NOT void for owners who attempt to repair defective units. Technical consultation is available by calling (662) 323-5869.
5. This warranty does not apply to kits sold by or manufactured by MFJ Enterprises, Inc.
6. Wired and tested PC board products are covered by this warranty provided only the wired and tested PC board product is returned. Wired and tested PC boards installed in the owner's cabinet or connected to switches, jacks, or cables, etc. sent to MFJ Enterprises, Inc. will be returned at the owner's expense unrepaired.
7. Under no circumstances is MFJ Enterprises, Inc. liable for consequential damages to person or property by the use of any MFJ products.
8. Out-of-warranty Service: MFJ Enterprises, Inc. will repair any out-of-warranty product provided the unit is shipped prepaid. All repaired units will be shipped COD to the owner. Repair charges will be added to the COD fee unless other arrangements are made.
9. This warranty is given in lieu of any other warranty expressed or implied.
10. MFJ Enterprises, Inc. reserves the right to make changes or improvements in design or manufacture without incurring any obligation to install such changes upon any of the products previously manufactured.
11. All MFJ products to be serviced in-warranty or out-of-warranty should be addressed to MFJ Enterprises, Inc., 300 Industrial Park Road, Starkville, Mississippi 39759, USA and must be accompanied by a letter describing the problem in detail along with a copy of your dated proof-of-purchase.
12. This warranty gives you specific rights, and you may also have other rights, which vary from state to state.